

KES

SINK DRAIN INSTALLATION GUIDE

S2007

S2008

S2017

S2018

CUSTOMER SERVICES

cs@keshome.com



CHAT NOW

S2007.V3.0

WARNING

To reduce the risk of injury or property damage, read all instructions before installing product. Wear safety goggles. The product must be installed in accordance with all state & local plumbing & building codes. Call a professional if you are uncertain about installing this product.

ILLUSTRATED PARTS

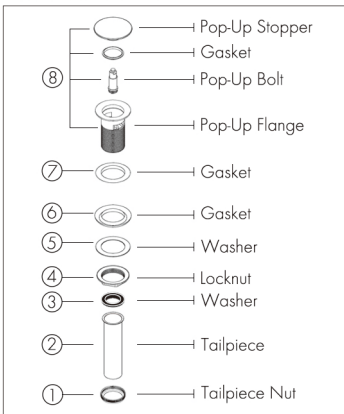

Remove tailpiece nut ①, tailpiece ②,
1 washer ③, locknut ④, washer ⑤,
gasket ⑥ from the drain body ⑧.

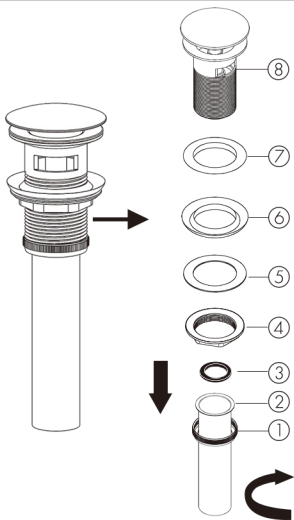

2 Install drain body (8), with gasket (7) attached, into the drain hole.

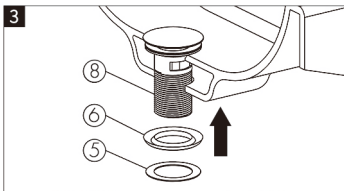
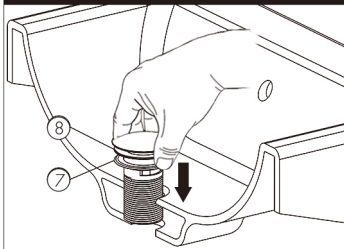

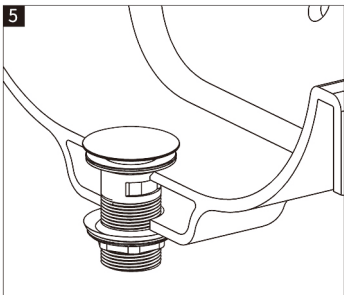
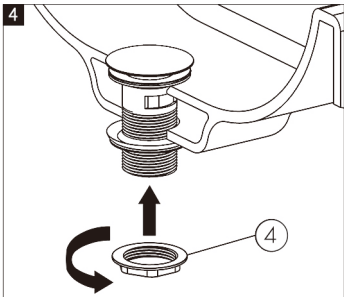

6

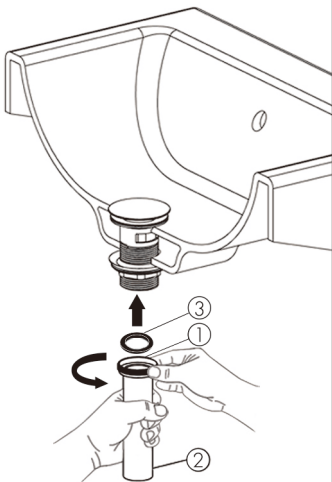

7

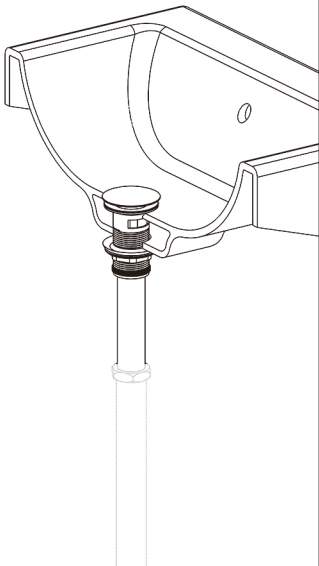

6

TROUBLESHOOTING

If the drain does not work properly, please take the following corrective actions:

1. PROBLEM

Pop-up stopper sticks and is hard to push down.

CAUSE

The pop-up bolt is jammed.

ACTION

Contact us to replace the pop-up bolt.

2. PROBLEM

The pop-up flange (or strainer basket) and the pop-up stopper aren't straight.

CAUSE

The package may have been damaged during transit.

ACTION

Try straightening the part or contact us for a how-to video guide.

3. PROBLEM

The drain is leaking underneath the sink.

CAUSE

The gasket ⑦ doesn't seal strong enough.

ACTION

Adjust the gasket or seal around it with the silicone caulk.

4. PROBLEM

There's a leak between the gasket ⑤, ⑥ and the locknut.

CAUSE

The gasket ⑥ may be upside down or the locknut doesn't seal strong enough.

ACTION

Remove the locknut and the gasket ⑥, then use plumbers tape or silicone caulk on the thread. Check that the gasket is right side up before putting it back on the gasket ⑥ along with the locknut.

5. PROBLEM

Size is not compatible.

CAUSE

This is made for a standard 1 3/4" drain opening. It fits sink hole with a diameter of 1 39/64" to 1 31/32" and sink with a max thickness of 1 31/32".

ACTION

Measure and check the size of your drain before installing. If it's not compatible, put all the items back in the box and return the product to Amazon.

6. PROBLEM

Drains slowly or water is unable to drain.

CAUSE

Debris is blocking the drain.

ACTION

Check and clean the drain.

One-Year Limited Warranty

KES warrants its products purchased from authorized sellers to be free from defects in material and workmanship for one (1) year from the original date of purchase.

What We Will Do

KES will repair or replace, FREE OF CHARGE, during the one (1) year warranty period, any part that proves defective in material and/or workmanship under normal installation, use and service.

If repair or replacement is not practical, KES may elect to refund the purchase price in exchange for the return of the product.

What Is Not Covered

KES shall not be liable for any damage to the product resulting from reasonable wear and tear, installation and maintenance errors, outdoor use, freezing water, abuse, misuse, and use of

cleaners containing abrasive cleansers, ammonia, bleach, acids, waxes, alcohol or other organic solvents.

KES is not responsible for removal, installation, labor charges, or other incidental or consequential costs. In no event shall the liability of KES exceed the purchase price of the product.

KES AND/OR SELLER ARE PROVIDING THESE WARRANTIES IN LIEU OF ALL OTHER WARRANTIES, EXPRESSED OR IMPLIED, INCLUDING BUT NOT LIMITED TO THE IMPLIED WARRANTIES OF MERCHANTABILITY AND FITNESS FOR A PARTICULAR PURPOSE. KES AND/OR SELLER DISCLAIM ALL LIABILITY FOR SPECIAL, INCIDENTAL OR CONSEQUENTIAL DAMAGES.

Some jurisdictions do not allow the exclusion or limitation of incidental or consequential damages, so these limitations and exclusions may not apply

to you. This warranty gives you specific legal rights and you may also have other rights which vary from jurisdiction to jurisdiction.

This warranty applies only to KES products sold in North America and Europe.

Contact KES

Email: cs@keshome.com

Online Contact:



Please provide:

- Dated proof of purchase;
- Description of the defect/fault;
- Picture or video showing the issue(s) (optional).

KES

Keep Efficient Simple