

KES

TOWEL BAR INSTALLATION GUIDE

A2000B

CUSTOMER SERVICES

cs@keshome.com



CHAT NOW

A2000B.V3.0

WARNING

To reduce the risk of injury or property damage, read and follow all the installation instructions before installing this product.

PRODUCT INTRODUCTION

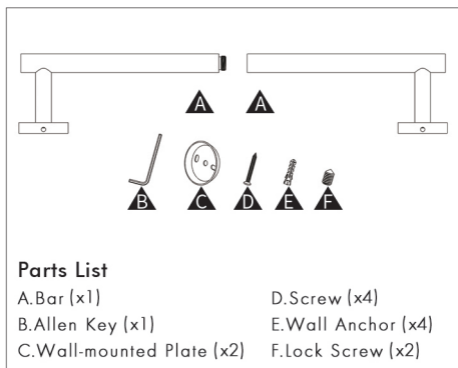

HELPFUL TOOLS

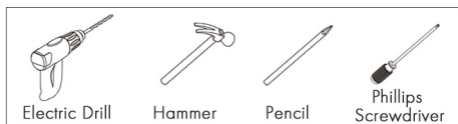

SCREW-MOUNT INSTALLATION

Notice ▲ Drill-bit size: 6mm (15/64")

- 1 Remove the wall-mounted plate.

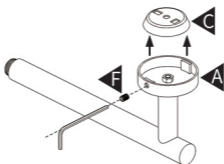

- 2

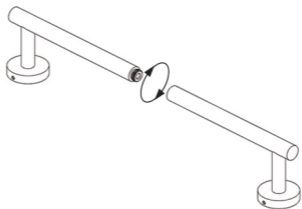

- 3 Gently place the product against the wall.
Push the bottom of posts flush against the wall.

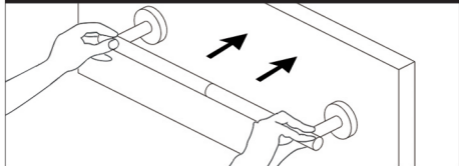

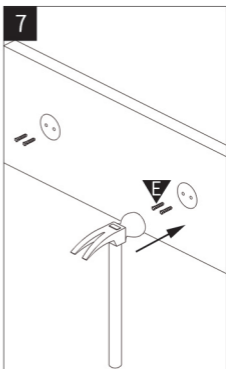
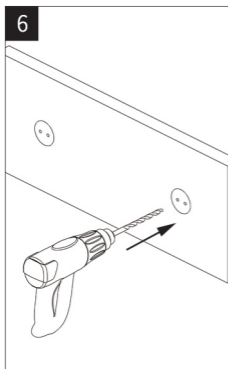
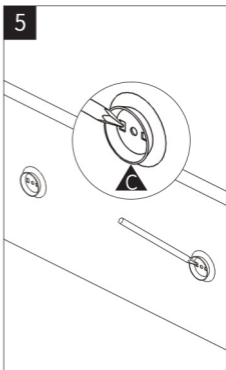
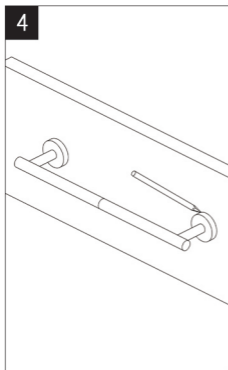

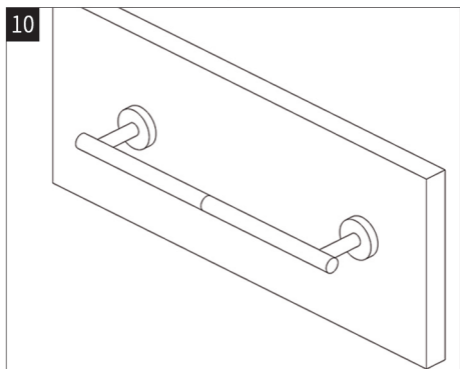
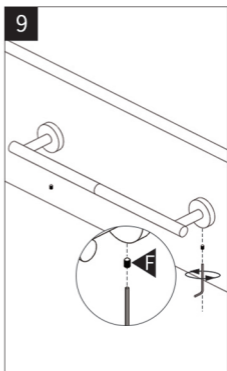
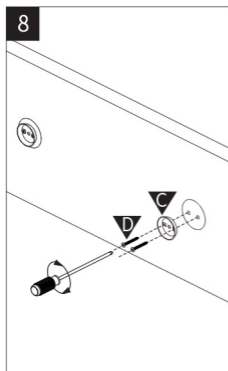

One-Year Limited Warranty

KES warrants its products purchased from authorized sellers to be free from defects in material and workmanship for one (1) year from the original date of purchase.

What We Will Do

KES will repair or replace, FREE OF CHARGE, during the one (1) year warranty period, any part that proves defective in material and/or workmanship under normal installation, use and service.

If repair or replacement is not practical, KES may elect to refund the purchase price in exchange for the return of the product.

What Is Not Covered

KES shall not be liable for any damage to the product resulting from reasonable wear and tear, installation and maintenance errors, outdoor use, freezing water, abuse, misuse, and use of cleaners containing abrasive cleansers, ammonia, bleach, acids, waxes, alcohol or other organic solvents.

KES is not responsible for removal, installation, labor charges, or other incidental or consequential costs. In no event shall the liability of KES exceed the purchase price of the product.

KES AND/OR SELLER ARE PROVIDING THESE WARRANTIES IN LIEU OF ALL OTHER WARRANTIES, EXPRESSED OR IMPLIED, INCLUDING BUT NOT LIMITED TO THE IMPLIED WARRANTIES OF MERCHANTABILITY AND FITNESS FOR A PARTICULAR PURPOSE. KES AND/OR SELLER DISCLAIM ALL LIABILITY FOR SPECIAL, INCIDENTAL OR CONSEQUENTIAL DAMAGES.

Some jurisdictions do not allow the exclusion or limitation of incidental or consequential damages, so these limitations and exclusions may not apply to you. This warranty gives you specific legal rights and you may also have other rights which vary from jurisdiction to jurisdiction.

This warranty applies only to KES products sold in North America and Europe.

Contact KES

Email: cs@keshome.com

Online Contact:



Please provide:

- Dated proof of purchase;
- Description of the defect/fault;
- Picture or video showing the issue(s) (optional).



FR

**Pensez à
donner ou recycler.**



Association

ou



Magasin

ou



Déchèterie

<https://quefairedemesdechets.fr>